

UDC 629.014.3

## Air velocity modeling velocity of the air around the trunk road train with installed rolling roof fairings

Nesterenko Mykola<sup>1</sup>, Skoryk Maksym<sup>2\*</sup>, Shapoval Mykola<sup>3</sup>, Nesterenko Mykola<sup>4</sup>

<sup>1</sup> Poltava National Technical Yuri Kondratyuk University <https://orcid.org/0000-0002-8961-2147>

<sup>2</sup> Poltava National Technical Yuri Kondratyuk University <https://orcid.org/0000-0001-9001-4913>

<sup>3</sup> Poltava National Technical Yuri Kondratyuk University <https://orcid.org/0000-0002-6943-7687>

<sup>4</sup> Poltava National Technical Yuri Kondratyuk University <https://orcid.org/0000-0002-4073-1233>

\*Corresponding author E-mail: maxym.skoryk@gmail.com

The new rolling roof fairing installed in the tractor non-bonnet cab main train layout constructing are given. After analyzing existing exhausting elements installed on the tractor highway trailer and a large number of roof rails, it has been substantiated the expediency of installing a movable rope on the tractor roof, which can change the angle of the trailer airflow link with the combination of two movements - vertical and horizontal. The combination of these movements enables to change the parameters of streamline. For this purpose, the basic hydraulic control scheme is designed, which has a number of advantages: the starting units movements smoothness, the ability to continuously adjust the speed in a wide range, low inertia, simplicity of management and automation, high operational reliability and resistance to overload. Due to the modern capabilities and development of sophisticated electronic control systems through the introduction of such a system in the control process of hydraulic cylinders can ensure the system reliability, efficiency, ergonomics and safety equipment.

**Keywords:** main motorway, streamlined, roof fairings, hydraulic control scheme.

## Моделювання швидкості руху повітря навколо магістрального автопоїзда із установленим рухомим даховим обтічником

Нестеренко М.П.<sup>1</sup>, Скорик М.О.<sup>2\*</sup>, Шаповал М.В.<sup>3</sup>, Нестеренко М.М.<sup>4</sup>

<sup>1, 2, 3, 4</sup> Полтавський національний технічний університет імені Юрія Кондратюка

\*Адреса для листування E-mail: maxym.skoryk@gmail.com

Наведено результати конструювання нового рухомого дахового обтічника, який установлюється на кабіні безкапотного компонування тягача магістрального автопоїзда. Після аналізу існуючих обтічних елементів, які встановлюються на тягач магістрального автопоїзда, та великої кількості саме дахових обтічників було обґрунтовано доцільність установлення рухомого обтічника на даху тягача, котрий може змінювати кут обтікання повітрям причіпної ланки за допомогою комбінації двох рухів – вертикального і горизонтального. Поєднання цих рухів надасть можливість найбільш просто змінювати параметри обтічності. Для цього спроектовано принципову гідравлічну схему керування обтічником, яка має ряд переваг: плавність рухів вихідних ланок, можливість безступінчастого регулювання швидкості у широкому діапазоні, мала інерційність, простота керування й автоматизації, висока експлуатаційна надійність та стійкість до перевантажень. Завдяки сучасним можливостям і розвитку складних електронних систем керування шляхом упровадження такої системи у процесі керування гідроциліндрами можна забезпечити надійність роботи системи, економічність, ергономічність та техніку безпеки. Таку гідравлічну схему можливо живити як від двигуна, так і від мережі живлення автомобіля. Керування можна виконувати автоматично, шляхом установлення гідророзподільника та регульованого дроселя до кабіни транспортного засобу і поєднання цих компонентів у єдиний блок управління. Побудована узагальнена тривимірна модель тягача, а також виконано графічне моделювання швидкості руху повітря навколо магістрального автопоїзда різного компонування із установленим даховим обтічником та без нього за допомогою Microsoft Excel та функції Flow Simulation від SolidWorks.

**Ключові слова:** магістральний автопоїзд, обтічність, даховий обтічник, гідравлічна схема керування.



## Introduction

The main trains are the main goods chain component transportation from the manufacturer to the final recipient because of their mobility and load capacity, as well as the branching of highways. It is not always possible for car dealers to buy a new tractor. The market of second-hand trucks in our country is developing; the old Soviet and post-Soviet trucks are being replaced at European level by large enterprises. For a potential buyer there is a number of estimated indicators – technical, functional, operational, and the optimal option is selected. One of the main performance indicators is fuel efficiency.

Since the main production feature of the main train is the speed of delivery to the destination, then the average technological speed at the same time is quite significant. It is proved that a significant part of the fuel consumed by a vehicle at high speed is needed to overcome the air resistance. Therefore, the decrease of the dynamic resistance of the motor-vehicle movement is the main factor affecting the final reduction of the cost of cost delivery that is the shortest way to obtain additional profits [1 – 3].

## Review of research sources and publications

A large number of authors investigated various complex bodies flow processes, which include the main motorway [1 – 5].

The nature and level of traffic main train jams is determined by the shape, structural features and parameters of the air environment. The rectangular shape of the transverse and longitudinal section of the modern highway trains, in combination with flat walls, provides the most useful space for placing the cargo in them, but it is unsatisfactory from the aerodynamics view point. At the same time, in the case of on-board trucks, the main component of their frontal projection is the cab frontal area, then in the main road trains with high bodies, approximately the same size area above the cabin of the body front wall is added [4].

Analyzing the linear series of highway trains, it was determined that for them it is typical the presence of a body significant excess over the cabin, a large gap between them, as well as uncircumcised or rounded cabin and body frontal edge small radius [5]. All of these factors greatly reduce streamlinedness.

The author [4] considered in detail the complex main train flow mechanism with different layout schemes by counter and lateral wind. It has been proven that it has a negative impact on performance, namely aerodynamic stability, exchange rate stability, handling.

## Definition of unsolved aspects of the problem

The authors [6 – 9], in theoretical studies and trains aerodynamic properties graphical modeling, simply install separate rails in different places, both the tractor cab and the trailer link. It is permissible at the stage of designing new technology, although there are enough domestic and foreign cars used on roads, for which it does not solve the issue.

Among the large number of existing inventions, fender, located on the roof is the most commonly used; the side parts of the tractor remain the most effective. Its effectiveness is scientifically proven, but the application of one and the same ramp to different semitrailers, trailers, tanks causes a violation of the tractor aerodynamics. Such use is inappropriate and ineffective. In [9], the expediency of installing a very moving roof ramp, which enables to tune in to any link of the train.

## Problem statement

The purpose of the article is to develop a basic scheme and design of the roof ramp, a hydraulic system for changing the roof ramp parameters with the adjusting possibility for any trailer structure, as well as possible options for connecting and adjusting its parameters, based on the previous studies results [8 – 9], as well as different layouts air movement speed graphical modeling around the main train with the installed roof rails.

## Basic material and results

The overall height of the sidecar is determined by the trailer height couplings. The main resistance in them is created by air, which flows through the cabin and runs into the front wall of the semitrailer. In addition, in the intervals between the links of the automobile train powerful vortices are formed, which seem to increase the frontal area. Therefore, in various ways to reduce the aerodynamic resistance, various designs of the rails [6] are used which reduce the air resistance.

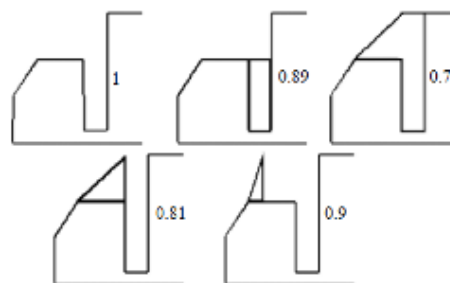


Figure 1 – Ways to improve the vibrancy of the trains by installing the roof rails

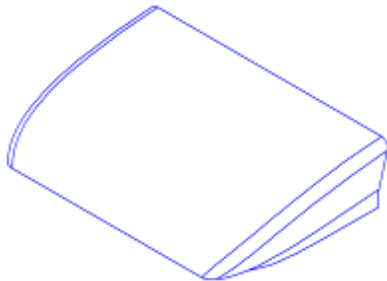
The flywheel is a necessary tool that enables to use the power of the truck most efficiently, as well as to save time and money.

Advantages of installing a strap on the roof of a truck for any trailer:

- helps to reduce the aerodynamic resistance of the oncoming airflow, and also increases the safety of traffic due to the road trains greater stability;
- provides high overstream rates due to the appropriate geometric parameters choosing possibility;
- provides ease of use and the ability to adjust the cushion when driving a car;
- enables to mount on any tractor and reinstall on other tractors without losing its technical characteristics and without changing overall dimensions;
- enables to achieve substantial fuel economy;

- enables to move faster without the cost of additional power providing superiority over competitors;
- reduces the load on the engine and reduces noise in the cabin resulting from the flow of air masses;
- improves aerodynamics and increases the car course stability and protects the semi-trailer body from wear, extending its service life;
- improves the truck outward.

The general view of the movable roof rails is shown in Figure 2.



**Figure 2 – General view of the proposed roof railing**

In [11] for the purpose of determining and constructing a mathematical model, several tractors were processed and their average parameters are presented in Table 1.

**Table 1 – The average parameters tractors**

Height of cabscab	Length, mm	Width, mm	Height, mm	Engine power, kW	Fuel consumption, l / 100 km
Average	6200	2500	3500	300	19-21
Low	6200	2500	2900	300	20-22

For these tractors, the coefficient change of frontal op pv depending on the form and the site of the roof fairing has been investigated, which is presented in Table 2.

**Table 2 – Drag coefficient changes on the parameters of the car and radome**

No	Height cab	Fairings	Location	Drag coefficient $C_x$
1	Average	None	-	1.08
		Straight	Behind	0.77
		Improved		0.52
2	Low	Absent	-	1.09
		Normal	Behind	0.85
		Improved		0.57
		Improved	Ahead	0.87

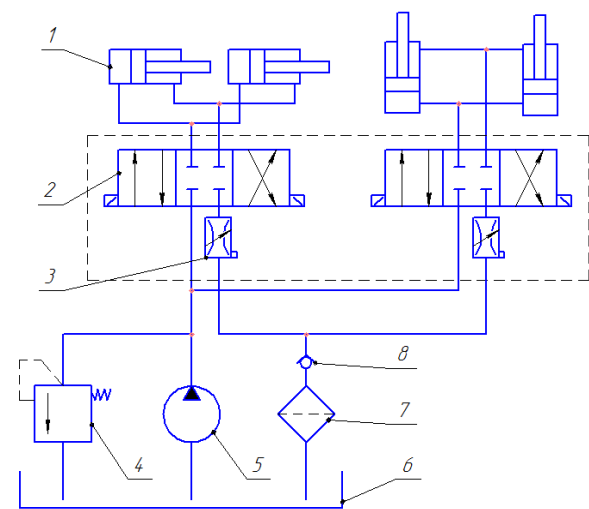
The research results have been used when calculating the changes in the amount of fuel consumed by the

flow of traffic. The relative savings of a tractor with a low cabin and an improved ramp make up 16.3% of the tractor without an outboard and 10.9% of the fitted with a conventional cushion. For an average cab with an improved ramp, the figures are 13.4% and 7.1% respectively [11]. These calculations point to the expediency of its use.

Of all the existing systems, it has been decided to choose a hydraulic control system because it provides:

- the movements smoothness of the output units;
- the possibility of stepless speed control in a wide range;
- small inertia;
- ease of management and automation;
- high operational reliability and resistance to overload.

The hydraulic scheme of the proposed control system is presented in Figure 3.



**Figure 3 – Hydraulic system for changing the parameters of the roof rails for any trailer structure:**

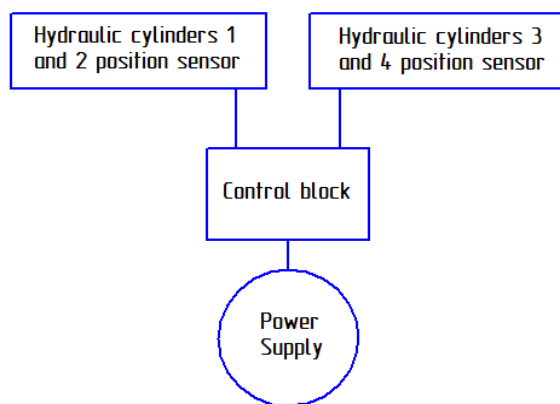
- 1 – hydraulic cylinder; 2 – hydraulic distributor;
- 3 – servo-choke; 4 – safety valve;
- 5 – hydraulic pump; 6 – oil tank;
- 7 – filter; 8 – check valve

The principle of this control system operation is that the liquid is absorbed from the oil tank by means of an unregulated pump with constant flow direction and fed to a hydraulic distributor with electromagnetic control. In the spool neutral position of the hydraulic distributor, when the pump is running, the pressure on the pipeline between the pump and the distributor begins to increase, with the safety valve triggered and the liquid is merged into the tank. When changing the position of the spool, open passage sections in the distributor and the liquid begin to enter the piston cavity of the hydraulic cylinder. From the rod cavity of the hydraulic cylinders, the fluid through the drainage line passes through a hydraulic distributor, regulated chokes with a servo drive and cleaned by a filter, fall into the drains in the tank.

The hydraulic cylinders rods translational velocity movement is controlled by the chokes. Reversal of the

rods is carried out by switching the positions of the hydraulic distributor. In emergency stops (for example, an insurmountable effort), the pressure in the system increases, thereby causing the opening of the safety valve and the discharge of the working fluid into the tank.

Due to modern capabilities and the development of complex electronic control systems, the implementation of such a system in the process of managing the hydraulic cylinders can ensure the reliability of the system (long inter-repair period, control and shutdown during excessive pressure on the system, interconnection with the onboard computer, etc. ), profitability (ensuring the operation of the equipment within the limits of rational parameters and operating modes), ergonomics (ease of use) and safety techniques (prevention of the occurrence of many types of injury during system operation).

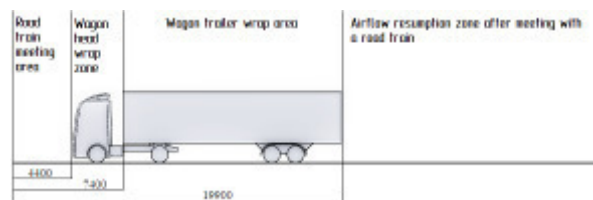


**Figure 4 – Structural diagram of the hydraulic system for changing the parameters of the roof rails under any trailing structure**

Such a hydraulic circuit can be fed, both from the engine and from the car power supply. Due to modern control electronics, it is possible to change the ramp position without leaving the tractor, by installing a hydraulic distributor and an adjustable throttle to the vehicle cab, and combining these components into a single control unit. Also, when connecting the control unit to the on-board computer, the system itself can set optimal parameters for the conditions, than reduce the human impact on the system and prevent the equipment from failing during strong wind gusts. Hydraulic cylinders sensors show a change in the stem departure and provide precise control of the change in the strapping element overall dimensions.

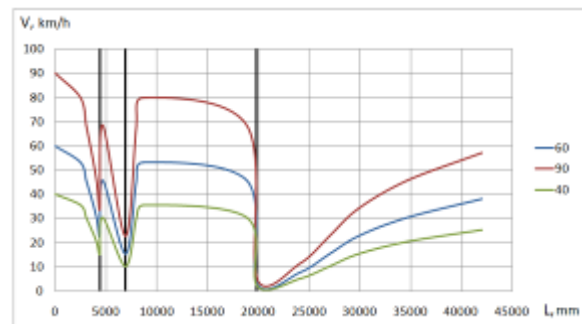
Main train car air speed graphic modeling around the different layouts with the installed roof rails.

The imaginary autotrains has been divided into the air flow zone with its flow in the projection of the road and the air velocity in these zones has been determined (Fig. 5).

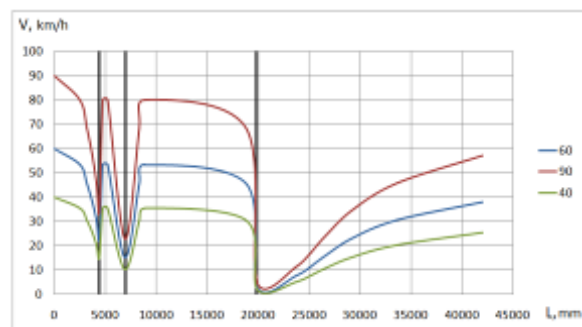


**Figure 5 – Schematic representation of air flow zones when traversing the trains**

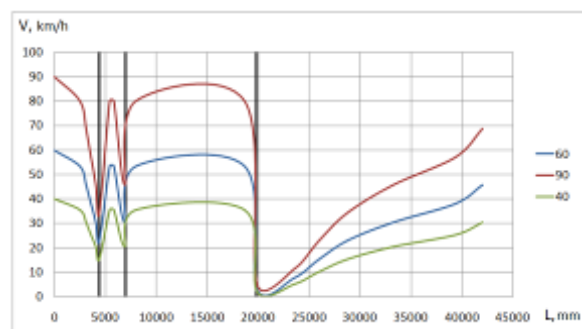
With Microsoft Excel, the air flow around the main trains of different layouts has been simulated at 40, 60 and 90 km/h.



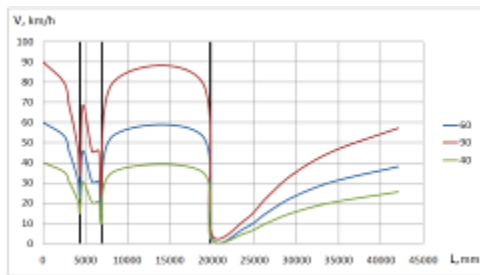
**Figure 6 – Figure velocity of the air around the main road train low cab without a radome**



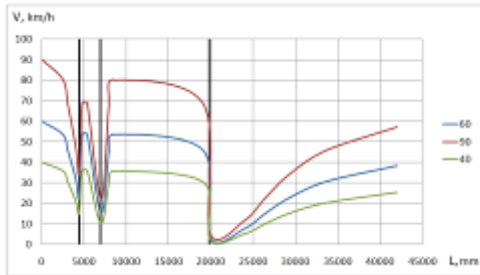
**Figure 7 – Figure velocity of the air around the main road train with a low cabin and improved fairing front**



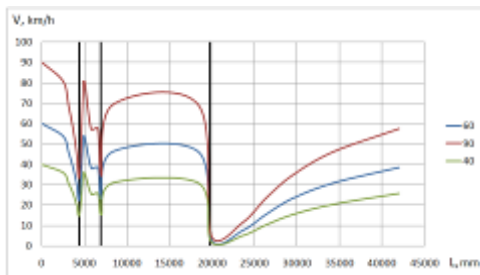
**Figure 8 – Figure velocity of the air around the main road trains with low cab with improved fairing behind**



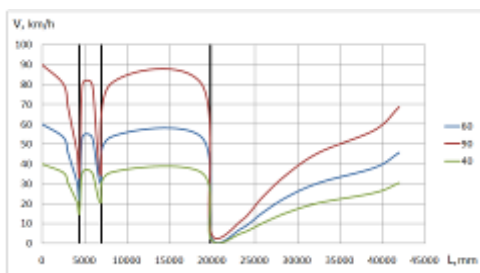
**Figure 9 – Chart air velocity around the main road trains with low cabin with conventional fairing**



**Figure 10 – Chart air velocity in Circle of main road trains with an average cabin without random**



**Figure 11 – Chart air velocity around the main road trains with an average cabin with conventional fairing**



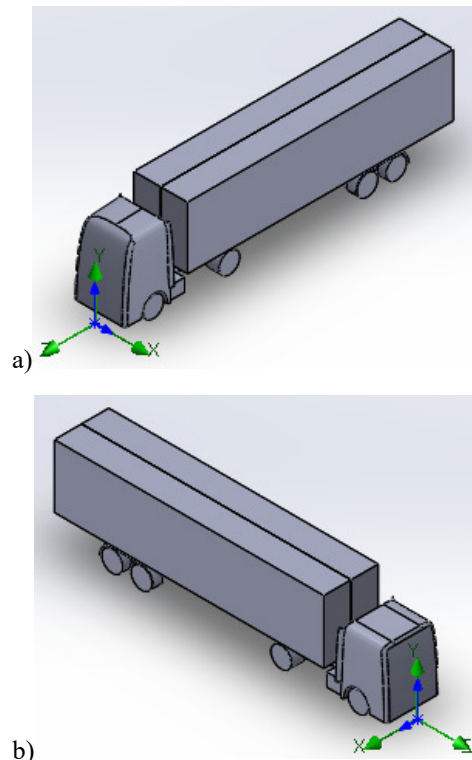
**Figure 12 – Chart air velocity around the main road trains with an average cabin with improved fairing**

Figure 6 – 12 shows a high-speed flow air different main road trains with and without roof railing. Vertical lines correspond to distances of 4400, 7400, 19900 mm, respectively. In front of any tractor, an excessive pressure is created which counteracts the car and tries to stop it, while in such a zone the speed of air movement decreases until it reaches directly the cabin of the

car. After this, a sharp jump of speed corresponds to the self-poison head flow, and the reduction behind it - the gap between the tractor and the impudent warehouse. The distance from 6950 to 19800 corresponds to the trailer flap. After this, the airflow separation from the rear of the trailer occurs, which is evidenced by a sharp decrease in speed. The rest is the restoration of the pest air velocity through the car.

Creation of three-dimensional models is more labor-intensive process than construction of their projections on a plane, but in this case of the three-dimensional modeling there is a number of advantages, among which:

- the possibility of considering the model from any position;
- automatic generation of the main and additional species on the plane;
- verification of interactions;
- engineering analysis;
- extraction of the characteristics required for production.



**Figure 13 – The appearance of the tractor:**  
a – cabin of average height; b – low-cabin

In the future, the Flow Simulation function has been used, which can simulate the flow of liquids and gases, control grid, use of typical physical models of liquids and gases, complex thermal calculation, gas, hydrodynamic and thermal models of technical devices.

With this package, the tractor traversing and flow velocity around it have been calculated.

The results of three-dimensional modeling correspond to the graphical dependences of previously calculated trains areas can be seen at Figures 14 – 20.



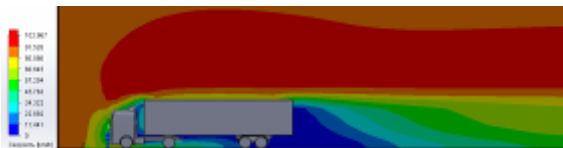
**Figure 14 – Flow chart of the main auto train with the average cabin**



**Figure 15 – Flow chart of the main train with a low cabin**



**Figure 16 – Flow chart of the main auto train with the average cabin and ordinary racing**



**Figure 17 – Flow chart of the main train with a low cabin and ordinary ramp**



**Figure 18 – Flow chart of the main train with an average cabin and an improved ramp**



**Figure 19 – Flow chart of the main train with a low cabin and a front upgraded ramp**



**Figure 20 – Flow chart of the main train with a with a low cab and located behind the improved ramp**

## Conclusions

The study of the main train trail streamline enabled to achieve the following results:

- after an analysis of the existing flow elements installed on the main train trailer and the revised large number of rotors mounted directly on its roof, it was substantiated the expediency of installing a movable rope on the tractor roof that can change the trailer rotation angle link air through a combination of two movements – vertical and horizontal;
- the hydraulic roof railing changing the parameters system with the possibility of adjustment for any trailer structure is developed;
- suggested variants of roof ramp parameters adjustment connection;
- a generalized three-dimensional model of a tractor and an advanced ramp has been created for conducting experiments on it;
- a graphical simulation of the air velocity around the mainline trailer of a different layout with and without the roof railing installed using Microsoft Excel and SolidWorks Flow Simulation functions;

The next step is to create accurate models of the most common tractors and study the passage of such cars through the flow of air, both with and without the outboard, it is possible to create a layout to confirm or refute the data through computer simulation.

## References

1. Вохминов, Д.Е., Коновалов, В.В., Московкин, В.В., Селифонов, В.В., Серебряков, В.В. (2000). *Методика расчета тягово-скоростных свойств и топливной экономичности автомобиля на стадии проектирования*. Москва: МГАПИ, МГТУ «МАМИ».
2. Choi, H., Lee, J. & Park, H. (2014). Aerodynamics of heavy vehicles. *Fluid Mechanics*, 46, 441 – 468.
3. Dalla Longa, L., Morgans, A.S. & Dahan, J.A. (2017). Reducing the pressure drag of a D-shaped bluff body using linear feedback control received: *Theoretical and Computational Fluid Dynamics*, 31 (5), 567-577.  
<https://doi.org/10.1007/s00162-017-0420-6>
4. Hucho, W.H. (1993). Aerodynamics of road vehicles: from fluid mechanics to vehicle engineering. *Fluid Mechanics*, 25, 485-533.
5. Acevedo-Giraldo, D., Botero-Bolivar, L., Munera-Palacio, D. & Garcia-Navarro, J.G. (2018). Aerodynamic evaluation of different car carrier devices for drag reduction using CFD. *Journal of Aerospace Technology and Management*, 10, 754-766.  
<http://dx.doi.org/10.5028/jatm.v10.971>
6. Kim, J.J., Lee, S., Kim, M., You, D. & Lee, S.J. (2017). Salient drag reduction of a heavy vehicle using modified cab-roof fairings. *Journal of Wind Engineering and Industrial Aerodynamics*, 164, 138-151.  
<https://doi.org/10.1016/j.jweia.2017.02.015>
7. Moldavanov, S.Yu. (2013). Forecasting of long-term strength of thermoelastic bodies under compression. *Journal of SWorld*, 3(2), 21 – 26.
8. Peng, J., Wang, T., Yang, T., Sun, X. & Li, G. (2018). Characteristics of tractor-trailers with a parametric cab design. *Appl. Sci.*, 8(5), 791-798.  
<https://doi.org/10.3390/app8050791>
9. Kim, J.J., Hong, J., & Lee, S.J. (2017). Bio-inspired cab-roof fairing of heavy vehicles for enhancing drag reduction and driving stability. *Journal of Mechanical Sciences*, 131, 868-879.  
<https://doi.org/10.1016/j.ijmecsci.2017.08.010>
10. Kim, J.J., Kim, J. & Lee, S.J. (2017). Substantial drag reduction of a tractor-trailer vehicle using gap fairings. *Journal of Wind Engineering and Industrial Aerodynamics*, 171, 93–100.  
<https://doi.org/10.1016/j.jweia.2017.09.014>
11. Hyams, D.G., Sreenivas, K., Pankajakshan, R., Nichols, D.S., Briley, W.R. & Whitfield, D.L. (2011). Computational simulation of model and full scale Class 8 trucks with drag reduction devices. *Journal of Computers and Fluids*, 41(1), 27-40.  
<https://doi.org/10.1016/j.compfluid.2010.09.015>
12. Назаренко, І.І., Нестеренко, М.П. (2015). Методика досліджень загальної динамічної моделі «технологічна машина для будівельної індустрії – оброблюване середовище». *Техніка будівництва*, 34, 4-11.
1. Vokhminov, D.E., Konovalov, V.V., Moskovkin, V.V., Selifonov, V.V. & Serebryakov, V.V. (2000). *Method of calculation of traction-speed properties and fuel economy of the car at the design stage*. Moscow: MGAPI, MAMI Moscow State Technical University.
2. Choi, H., Lee, J. & Park, H. (2014). Aerodynamics of heavy vehicles. *Fluid Mechanics*, 46, 441 – 468.
3. Dalla Longa, L., Morgans, A.S. & Dahan, J.A. (2017). Reducing the pressure drag of a D-shaped bluff body using linear feedback control received: *Theoretical and Computational Fluid Dynamics*, 31 (5), 567-577.  
<https://doi.org/10.1007/s00162-017-0420-6>
4. Hucho, W.H. (1993). Aerodynamics of road vehicles: from fluid mechanics to vehicle engineering. *Fluid Mechanics*, 25, 485-533.
5. Acevedo-Giraldo, D., Botero-Bolivar, L., Munera-Palacio, D. & Garcia-Navarro, J.G. (2018). Aerodynamic evaluation of different car carrier devices for drag reduction using CFD. *Journal of Aerospace Technology and Management*, 10, 754-766.  
<http://dx.doi.org/10.5028/jatm.v10.971>
6. Kim, J.J., Lee, S., Kim, M., You, D. & Lee, S.J. (2017). Salient drag reduction of a heavy vehicle using modified cab-roof fairings. *Journal of Wind Engineering and Industrial Aerodynamics*, 164, 138-151.  
<https://doi.org/10.1016/j.jweia.2017.02.015>
7. Moldavanov, S.Yu. (2013). Forecasting of long-term strength of thermoelastic bodies under compression. *Journal of SWorld*, 3(2), 21 – 26.
8. Peng, J., Wang, T., Yang, T., Sun, X. & Li, G. (2018). Characteristics of tractor-trailers with a parametric cab design. *Appl. Sci.*, 8(5), 791-798.  
<https://doi.org/10.3390/app8050791>
9. Kim, J.J., Hong, J., & Lee, S.J. (2017). Bio-inspired cab-roof fairing of heavy vehicles for enhancing drag reduction and driving stability. *Journal of Mechanical Sciences*, 131, 868-879.  
<https://doi.org/10.1016/j.ijmecsci.2017.08.010>
10. Kim, J.J., Kim, J. & Lee, S.J. (2017). Substantial drag reduction of a tractor-trailer vehicle using gap fairings. *Journal of Wind Engineering and Industrial Aerodynamics*, 171, 93–100.  
<https://doi.org/10.1016/j.jweia.2017.09.014>
11. Hyams, D.G., Sreenivas, K., Pankajakshan, R., Nichols, D.S., Briley, W.R. & Whitfield, D.L. (2011). Computational simulation of model and full scale Class 8 trucks with drag reduction devices. *Journal of Computers and Fluids*, 41(1), 27-40.  
<https://doi.org/10.1016/j.compfluid.2010.09.015>
12. Nazarenko, I.I. & Nesterenko, M.P. (2015). Research methodology of the general dynamic model «technological machine for construction industry – processed environment». *Construction Engineering*, 34, 4-11.